

CombiTherm Dämmelement 100/60

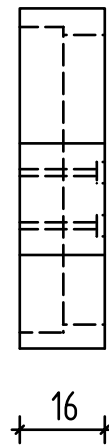

Tiefe Anschlag in Dämmelement
 ist abhängig von Fenster
 0,7 Ug = Tiefe 7cm
 0,6 Ug = Tiefe 8,2cm

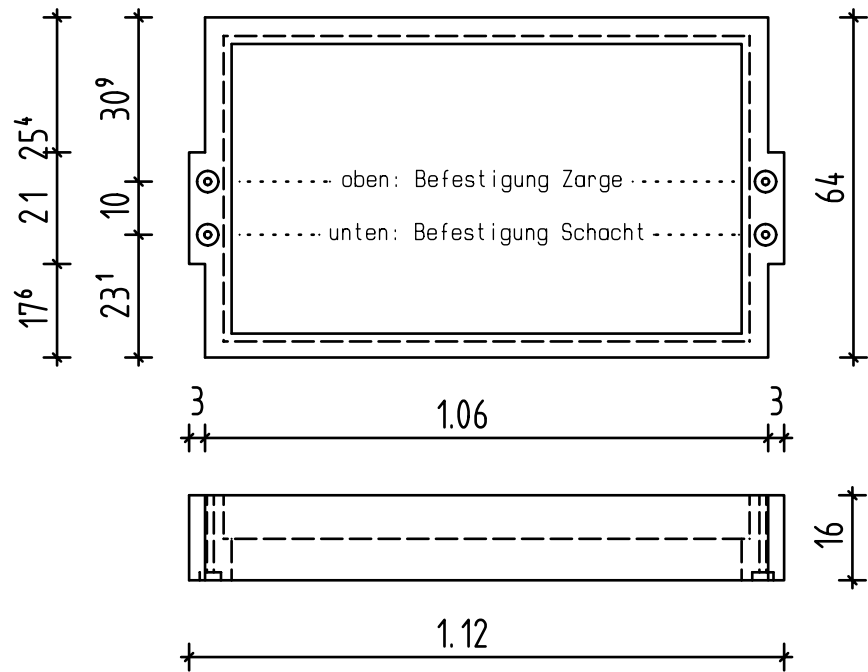