

CombiTherm Dämmelement 120/100

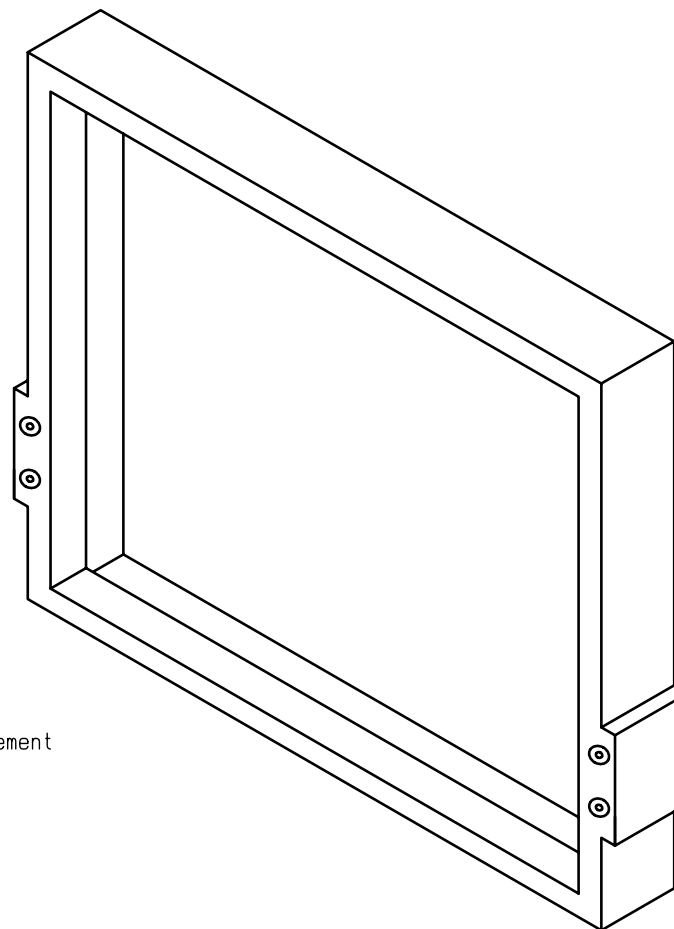
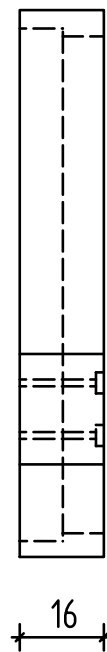
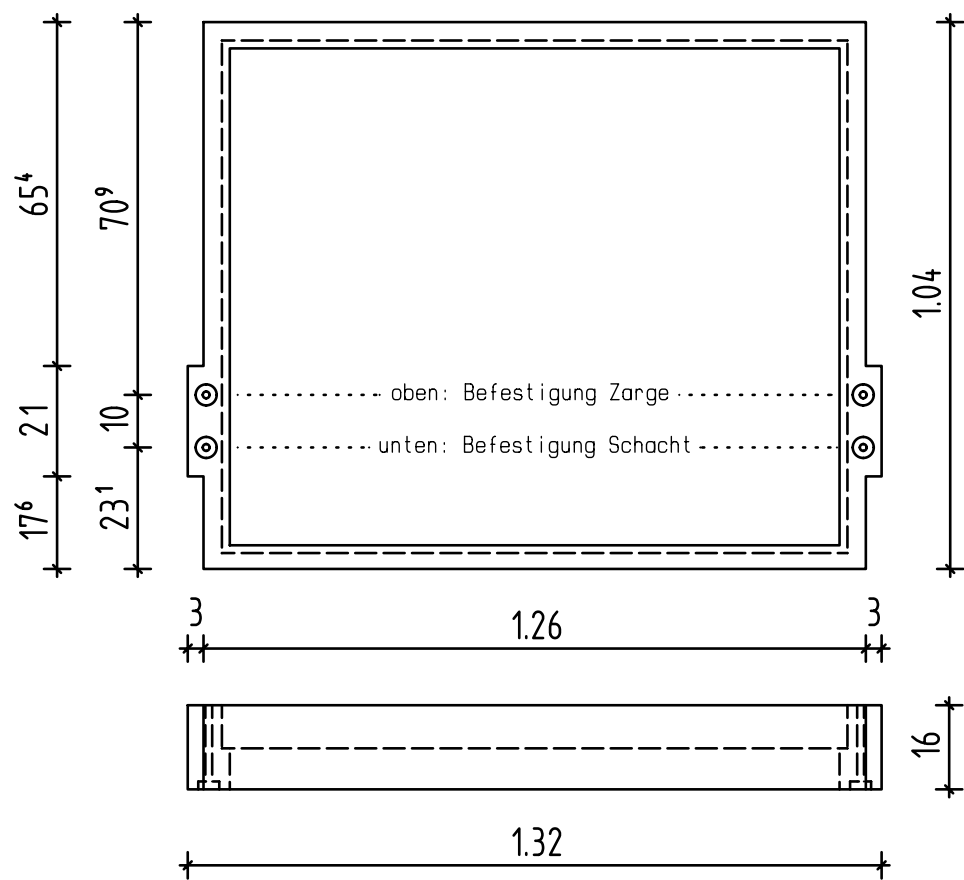

Tiefe Anschlag in Dämmelement
ist abhängig von Fenster
0,7 Ug = Tiefe 7cm
0,6 Ug = Tiefe 8,2cm